

SUNNY STUFF





Entdecken Sie die Welt von Sunkid

Alla scoperta del mondo di Sunkid

8

TOCHTERUNTERNEHMEN
AZIENDE

+45

VERTRIEBSPARTNER
PARTNER DI DISTRIBUZIONE

+9.000

PROJETTE WELTWEIT
PROGETTI COMPLETATI

1996

GRÜNDUNGSJAHR
ANNO DI FONDAZIONE

Sunkid ist ein weltweit führender Ganzjahresanbieter von Freizeitattraktionen für die ganze Familie. Von einzelnen ausgesuchten Attraktionen bis hin zur individuellen Gesamt-Konzeptionierung, Produktion und schlüsselfertigen Umsetzung bietet Sunkid eine Fülle an Produkten und Dienstleistungen. Mit über 9.000 realisierten Projekten in über 80 Ländern auf der ganzen Welt, einem Netzwerk aus 8 Unternehmen und 45 Vertriebs- und Servicepartnern steht Sunkid für höchste Qualität und verlässlichen Service.

Sunkid è un produttore leader a livello mondiale di attrazioni 365 giorni all'anno per il tempo libero destinate a tutta la famiglia. Sunkid offre un'ampia gamma di prodotti e servizi che vanno da singole attrazioni selezionate fino alla progettazione complessiva personalizzata, alla produzione e alla realizzazione chiavi in mano. Con oltre 9.000 progetti realizzati in più di 80 paesi in tutto il mondo, una rete di 8 aziende e 45 distributori e centri di assistenza tecnica, Sunkid è sinonimo di massima qualità e servizio affidabile.

INHALTSVERZEICHNIS

INDICE



SNOW ANIMALS | Seite 34 – 35
SNOW ANIMALS | pagina 34 – 35



TOUCAN & CO | Seite 26 – 28
TOUCAN & CO | pagina 26 – 28



SCHNEEPFLUGHILFEN | Seite 20 – 21
AIUTO SPAZZANEVE | pagina 20 – 21



SUNLINE | Seite 44 – 47
SUNLINE | pagina 44 – 47



ROTONDO | Seite 51
ROTONDO | pagina 51

PLANUNG & PROJEKTE	4
<i>PIANIFICAZIONE E PROGETTI</i>	
PROJEKTE	8
<i>PROGETTI</i>	
ZÄUNE, TRANSPARENTE UND ABSPERRLEINEN	15
<i>RECINZIONI, STRISCIONI E FUNI DI DELIMITAZIONE</i>	
HILFSMITTEL & ZUBEHÖR	17
<i>MEZZI AUSILIARI ED ACCESSORI</i>	
SCHNEEPFLUGHILFEN	20
<i>AIUTO SPAZZANEVE</i>	
SITZMÖGLICHKEITEN	23
<i>POSTAZIONI A SEDERE</i>	
SPIEL & SPASS	24
<i>GIOCHI E DIVERTIMENTO</i>	
TOUCAN & CO	27
EINGANGSBOGEN	29
<i>ARCO D'INGRESSO</i>	
MONSTER FAMILY	31
INTERAKTIVER SKIKINDERGARTEN	33
<i>ASILO DA SCI INTERATTIVO</i>	
SNOW ANIMALS	34
TROLL FAMILY	36
SKIREGELN	37
<i>REGOLE PER SCIARE</i>	
VERKEHRSZEICHEN, WALDABFAHRT & LAUTSPRECHER	38
<i>SEGNALETICA, DISCESA NEL BOSCO E ALTOPARLANTI</i>	
RACE-ELLIPSEN	40
<i>ELLISSI DA GARA</i>	
KIDS OBSTACLES	41
RACE EQUIPMENT	42
STARTHAUS & ZIELSÄULEN	43
<i>PUNTO DI PARTENZA & COLONNINE D'ARRIVO</i>	
SUNLINE	44
SNOW FUN PARK	48
ROTONDO	51

PLANUNG & PROJEKTE

PIANIFICAZIONE E PROGETTI

Komplettangebot: „Alles aus einer Hand“

Von der Inspiration, über die maßgeschneiderte Planung, bis hin zur schlüsselfertigen Umsetzung im individuellen Design: Sunkid bietet Ihnen ein durchdachtes Erlebnis für Ihre Gäste.

Eine Auswahl an erfolgreich mit unseren Kunden geplanten und umgesetzten Projekten finden Sie ab Seite 8.

Offerta completa: "Tutto da una sola fonte"

Dall'ispirazione alla progettazione personalizzata, fino alla realizzazione chiavi in mano di un progetto individuale: Sunkid vi offre un'esperienza ben studiata per i vostri ospiti.

Una selezione di progetti pianificati e realizzati con successo con i nostri clienti si trova a partire da pagina 8.



INDIVIDUELLE LÖSUNGEN

SOLUZIONI PERSONALIZZATE

Individuelles Design bei fast allen Sunny-Staff-Produkten möglich!

Design personalizzato per quasi tutti i prodotti Sunny Stuff!

Verleihen Sie unseren Produkten Ihren individuellen Touch

Ihren Wünschen und Ideen sind keine Grenzen gesetzt. Unterschiedlichste Materialien und Gestaltungsformen werden Ihre Gäste begeistern. Ob als einzelne Produkte oder vollendet in einem umfassenden Konzept für Kinderländer oder Skipisten. Sunkid unterstützt Sie – angefangen bei Ihrer Idee, weiter bei der Auswahl passender Produkte, bis hin zu Erstellung, Design und Fertigung der einzelnen Produkte.

Un tocco di personalizzazione ai prodotti di sunkid

Sunkid non pone limiti a desideri e idee. I materiali e le forme degli allestimenti più svariati si traducono in una vera e propria sorpresa per gli ospiti. Singoli articoli o soluzioni complete in progetti ampi per i paesaggi per bambini o piste da sci: Sunkid offre supporto ai clienti a partire dalle idee passando per la selezione dei prodotti adatti fino ad arrivare alla creazione del design e alla realizzazione dei singoli prodotti.

1 IDEE & ANFRAGE IDEA E RICHIESTA



2 PRODUKTAUSWAHL SELEZIONE DEL PRODOTTO

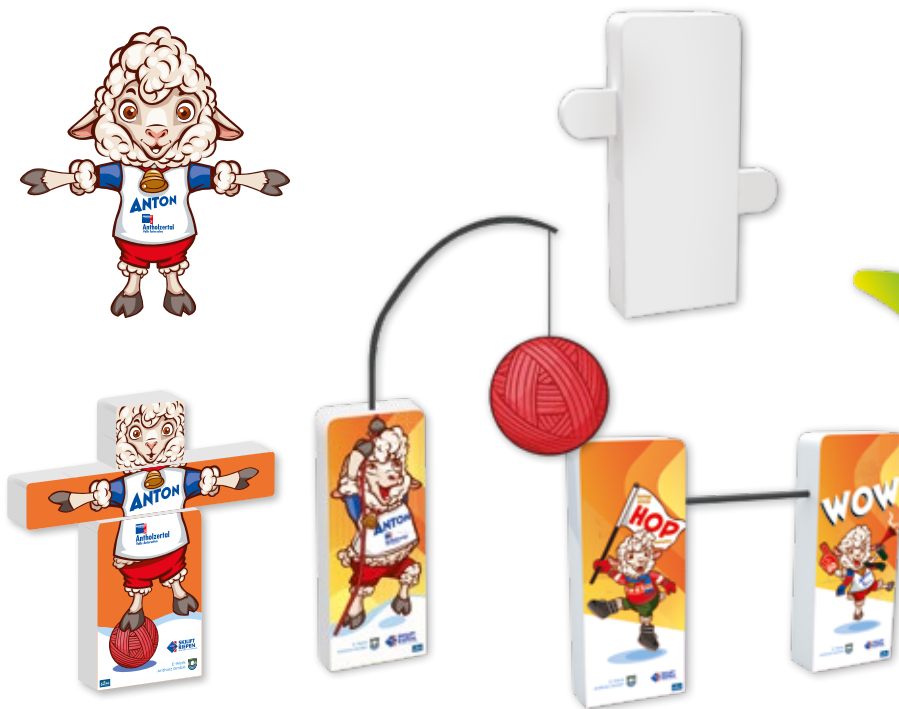

3 ERSTELLUNG: DESIGN & DRUCKDATEN CREAZIONE: DATI DI PROGETTAZIONE E STAMPA



SUNKIDWORLD



Einzigartige Planung & Beratung

Sparen Sie sich Kosten durch teure Fehlplanung. Überzeugen Sie Partner und Investoren und bieten Sie Ihren Gästen ein von Grund auf durchdachtes und inszeniertes Erlebnis.

Ob Neuerrichtung eines Skischulareals, Erweiterung im Skigebiet oder für einen mehrjährigen Investitionsplan: Unser Team aus Architekten und Visualisierern bietet Ihnen noch nie dagewesene Möglichkeiten.

Gerne stehen wir für Sonderwünsche, wie individuelle Formen und Designs, zur Verfügung und bieten Ihnen professionelle Unterstützung durch unser Design-Team.

+43 5412 68131 – info@sunkidworld.com

Pianificazione e consulenza uniche

In questo modo si evitano le spese dovute a costose pianificazioni errate, si offrono soluzioni convincenti a partner ed investitori e si assicurano agli ospiti esperienze ben congegnate e allestite da tutti i punti di vista.

A prescindere dalle nuove realizzazioni delle zone per scuole di sci, dagli ampliamenti in impianti sciistici o da programmi d'investimento pluriennale, lo staff di Sunkid formato da architetti e progettisti offre ai clienti opportunità senza precedenti.

Sunkid è a completa disposizione per richieste speciali, come ad esempio formati e progettazioni personalizzati, offrendo alla clientela un supporto professionale grazie allo staff addetto al design.

+43 5412 68131 – info@sunkidworld.com





PROJEKTE

PROGETTI

Hopsi-Winterkinderland

Das riesige Winterkinderland in Schladming (Österreich) lädt alle Ski-Anfänger und deren Familien zu „Hopsi’s Reise um die Welt“ auf Skiern ein. Jeder Parcours-Abschnitt ist genau auf die einzelnen Könnerebenen zugeschnitten. In allen Themenwelten (China, Australien, Nordpol, ...) gibt es individuell designte Sunny-Stuff-Elemente.

Hopsi-Winterkinderland

Il grande Winterkinderland di Schladming (Austria) invita tutti gli sciatori principianti e le loro famiglie a "Il viaggio di Hopsi intorno al mondo" sugli sci. Ogni sezione del percorso è adattata ai singoli livelli di abilità. Ci sono elementi Sunny Stuff progettati individualmente in tutti i mondi tematici (Cina, Australia, Polo Nord, ...).







Wollis Kids Park

Im Kinderland am Hauser Kaibling (Österreich) verbessert der Skinachwuchs stufenweise sein Können. Nicht nur Sunkid-Zauberteppiche und Pisten-Layouts sind auf die jeweiligen Entwicklungslevel zugeschnitten. Auch alle Sunny-Stuff-Elemente wurden nach dieser Systematik platziert.

Wollis Kids Park

Nel Kinderland di Hauser Kaibling (Austria), i giovani sciatori migliorano le loro abilità passo dopo passo. Non solo i Moving Carpets Sunkid e i tracciati delle piste sono adattati ai rispettivi livelli di sviluppo. Anche tutti gli elementi Sunny Stuff sono stati posizionati secondo questo sistema.





Spielerische Vorbereitung aufs Pistenvergnügen

Equipment-Produkte erleichtern das Lernen des Schneeflugs. Mit interaktiven Figuren macht das Kurvenfahren gleich noch mehr Spaß. Die Fortgeschrittenen wagen bereits die Fahrt über Obstacles oder die rasante Sunline. Weitere Spiel- und Späselemente sowie Sitzgelegenheiten sorgen in den Skischul-Pausen für Abwechslung.

Preparazione ludica per il divertimento in pista

I prodotti per l'equipaggiamento facilitano l'apprendimento dello sci. Le figure interattive rendono le curve ancora più divertenti. Gli sciatori più esperti osano già superare gli ostacoli o la veloce Sunline. Altri elementi ludici e divertenti, oltre a posti a sedere, offrono varietà durante le pause della scuola di sci.





Gasti Park

Von der initialen Idee bis zum laufenden Betrieb: In Bad Hofgastein (Österreich) entstand nach der musterhaften „Sunkidworld“ ein Premium-Kinderskiland, das nahezu das gesamte Produkt- und Service-Portfolio von Sunkid für den Winter am Berg beinhaltet.

Gasti Park

Dall'idea iniziale alla gestione corrente: A Bad Hofgastein (Austria) è stato creato un centro sciistico per bambini di alto livello basato sull'esemplare "Sunkidworld", che comprende quasi l'intero portafoglio di prodotti e servizi Sunkid per l'inverno in montagna.

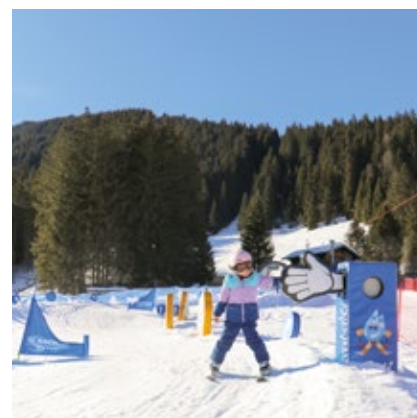

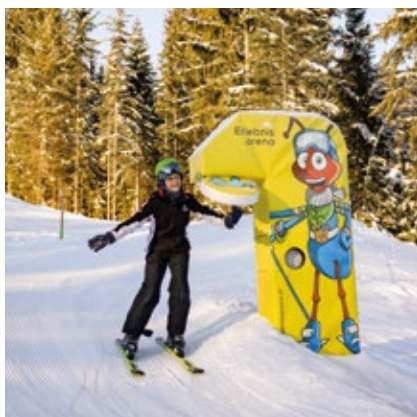

Familienskiland Wexl Arena

Interaktive Elemente bieten abwechslungsreiche Action und erhöhen den Spaß sowohl beim Skifahren als auch beim Rodeln. Im Kinderskiland lacht das Ameisen-Maskottchen „Corona“ von fast allen Sunny-Stuff-Elementen. Sunkid lieferte auch das passende Starthaus für die Rennstrecke.

Area sciistica per famiglie Wexl Arena

Gli elementi interattivi offrono un'azione varia e aumentano il divertimento sia nello sci che nello slittino. Nell'area sciistica per bambini, la formica mascotte "Corona" ride da quasi tutti gli elementi Sunny Stuff. Sunkid ha fornito anche il punto di partenza per la pista da corsa.



SICHERHEIT

SICUREZZA

Sicher durch den Winter

Um Skilehrern, Kindern und Wintersportlern ein Maximum an Spaß zu bieten, müssen bestimmte Rahmenbedingungen eingehalten werden. Diese umfassen Sicherheitsaspekte in mehrfacher Hinsicht. Deshalb bieten wir eine Reihe von Produkten an, um Sie diesbezüglich zu unterstützen. Alle Safety-Produkte können individuell nach Ihren Anforderungen gestaltet werden.

Sicurezza per tutto l'inverno

Per poter offrire ai maestri di sci, ai bambini e agli appassionati di sport invernali il massimo del divertimento, è necessario rispettare le condizioni quadro specifiche, fra cui gli aspetti di sicurezza sotto diversi punti di vista. Per questo motivo, Sunkid offre una gamma di prodotti per fornire un supporto adeguato in questi ambiti. Tutti i prodotti di sicurezza possono essere personalizzati a seconda delle esigenze dei clienti.



ZÄUNE, TRANSPARENTE UND ABSPERRLEINEN

RECINZIONI, STRISCIONI E FUNI DI DELIMITAZIONE



PE-Absperrzaun gelb/rot
Rete di delimitazione in PE giallo/rosso
24396 20 x 1,2 m, inkl. 9 Stangen / incl. 9 paletti
24397 10 x 1,2 m, inkl. 5 Stangen / incl. 5 paletti
24398 5 x 1,2 m, inkl. 3 Stangen / incl. 3 paletti



16948
Rolle gelb/rot
Rullo giallo/rosso
 50 m Rolle ohne Stangen
 Rullo di 50 m senza aste



PE-Absperrzaun gelb/blau
Rete di delimitazione in PE giallo/blu
1811 20 x 1,2 m, inkl. 9 Stangen / incl. 9 paletti
1812 10 x 1,2 m, inkl. 5 Stangen / incl. 5 paletti
16946 5 x 1,2 m, inkl. 3 Stangen / incl. 3 paletti



16945
Rolle gelb/blau
Rullo giallo/blu
 50 m Rolle ohne Stangen
 Rullo di 50 m senza aste



6101
Markierungsnetz blau
Rete di segnalazione blu
 20 x 0,6 m
 Inkl. 9 Stangen / incl. 9 paletti



6102
Markierungsnetz rot
Rete di segnalazione rosso
 20 x 0,6 m
 Inkl. 9 Stangen / incl. 9 paletti

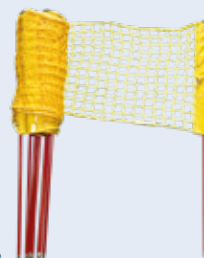

6103
Markierungsnetz gelb
Rete di segnalazione giallo
 20 x 0,6 m
 Inkl. 9 Stangen / incl. 9 paletti



6104
Markierungsnetz grün
Rete di segnalazione verde
 20 x 0,6 m
 Inkl. 9 Stangen / incl. 9 paletti



1803
Bunte Wimpelleine
Cordicella con bandierine colorate
 l = 30 m



Absperrleine individuell
Fune di delimitazione personalizzata
 Ein- oder beidseitiger Digitaldruck,
 Anzahl der Wimpel und Seillänge auf
 Wunsch
 Stampa digitale su uno o entrambi
 i lati, numero di gagliardetti e
 lunghezza della fune a richiesta



39053
Start-/Zielbanner | Striscione della partenza / dell'arrivo
 70 x 150 cm, inkl. einseitigen Druck und Transparentrahmen
 70 x 150 cm, incl. stampa su un lato e telaio dello striscione



Individueller Zaun | Recinzione personalizzata
 Stangen & Maße sind wählbar, wasser- und schmutzabweisend, luftdurchlässig, inkl. Klebeband fixierung und Abspannung
 Aste e dimensioni selezionabili a piacere, soluzione idrorepellente, resistente allo sporco e permeabile all'aria, incl. fissaggio con nastro adesivo e ancoraggio



TEACH & LEARN

Aus Freude am Lernen

Kindgerecht gestaltete Hilfsmittel, die nicht nur pädagogisch wertvoll sind, sondern auch Spaß und Abwechslung in den Unterricht bringen, gehören zu jeder modernen Skischule dazu. Wir legen größten Wert darauf, technische Innovationen und neue Produkte zusammen mit Skischulen zu entwickeln, damit Sie das bestmögliche Equipment zur Hand haben.

Il piacere dell'apprendimento

Gli strumenti ausiliari orientati ai bambini, che non sono solo preziosi a livello pedagogico, ma aggiungono anche divertimento e svago alle lezioni, fanno parte anche di tutte le moderne scuole di sci. In questo ambito, Sunkid presta grande attenzione a sviluppare soluzioni tecniche innovative e nuovi articoli insieme alle scuole di sci mettendo a disposizione della clientela l'attrezzatura migliore possibile.

HILFSMITTEL & ZUBEHÖR

MEZZI AUSILIARI ED ACCESSORI



35296
Handski | Sci per mani
 40 x 7 cm
 Inkl. Griff, inkl. Handschlaufe,
 inkl. Informationsflyer mit Übungsbeispielen
 Incl. impugnatura, incl. laccio da polso,
 incl. dépliant informativo con esercizi d'esempio



1813
Steppo
 215 x 60 cm



35766
Ski-Step-In Standard
 764 x 830 x 915 cm
 Inkl. Gitterrost und Halterung
 Incl. griglia e supporto



35765
Ski-Step-In Individuell
Ski-Step-In personalizzato
 764 x 830 x 915 cm
 Inkl. Gitterrost, Halterung und Werbetafel für individuelles Design
 Incl. griglia, supporto e pannello pubblicitario per personalizzazioni



Torbogen mit Glocke
Arco d'entrata con campanello
 h = 170 cm
 ■ 8260 ■ 8282



Selbstaufrichtend
Raddrizzamento automatico
Durchfahrtsbogen Flexi | Arco di passaggio Flexi
 100 x 120 cm
 ■ 25618 ■ 25619



8223
Tunnel S
 250 x 130 cm



Reifenset | Cerchi

1795 Ø ~66 cm
 25810 Ø ~38 cm
 Set aus 8 Stk. / Set da 8 pz.
 2 x ■ 2 x ■ 2 x ■ 2 x ■



25809
Stubbie Tasche | Borsa „Stubbie“
 l = 90 cm
 Inkl. Tragegurt
 Incl. cinghia da trasporto

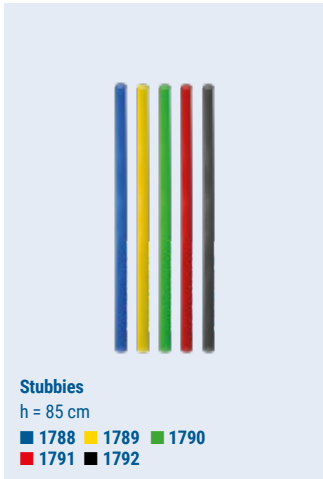

Stubbies
 h = 85 cm
 ■ 1788 ■ 1789 ■ 1790
 ■ 1791 ■ 1792



Schneepinsel | Spazzola da neve
 h = 64 cm
 ■ 1784 ■ 1785 ■ 1786
 ■ 1787 ■ 47388 ■ 47389



**bruchfest
infrangibileagli**

**Markierungskegel
Cono da segnalazione**
 Witterungsbeständiges Material
 Materiale resistente agli agenti atmosferici
 h = 45 cm
 ■ 1772 ■ 1773 ■ 1774 ■ 1775
 h = 30 cm
 ■ 1776 ■ 1777 ■ 1778 ■ 1779



1780
Markers
 Set aus 40 Stk., inkl. Stapel-/ und Transporthalter
 Set di 40 pz. con supporto da impilamento e trasporto
 10 x ■ 10 x ■ 10 x ■ 10 x ■



Pilz | Fungo
 h = 45 cm
 ■ 1768 ■ 1769



**Stangen mit Wimpel
Palo con bandierina**
 h = 160 cm
 ■ 1783 ■ 30044
 ■ 30045 ■ 30046



1808
Seilset | Set di corde
 l = 120 cm
 Set aus 10 Stk. / Set da 10 pz.
 2 x ■ 2 x ■ 2 x ■ 2 x ■ 2 x ■



16922
Fun Nudeln | Tubo galleggiante
 Set aus 10 Stk., Länge 160 cm, Ø 6,5 cm, farbig sortiert
 Set di 10 pz., lunghezza 160 cm, Ø 6,5 cm, colori assortiti

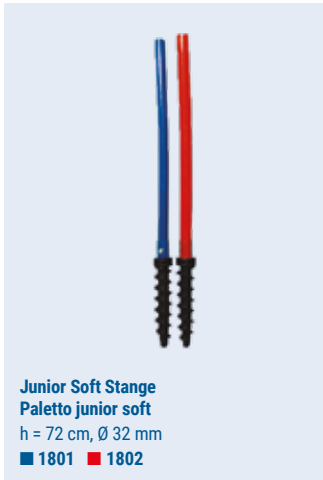

**Junior Soft Stange
Paletto junior soft**
 h = 72 cm, Ø 32 mm
 ■ 1801 ■ 1802

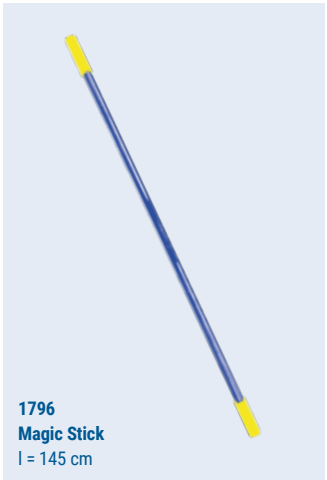

1796
Magic Stick
 l = 145 cm



1739
Soft Ring | Anello morbido
 Ø = 15 cm, 6 Stk. / 6 pz.
 2 x ■ 2 x ■ 2 x ■



16928
Bändchen Ringe | Anelli con nastri
 Set bestehend aus 6 Softringen (Art. 1739) und 36 Bändchen in jeweils 6 Farben
 Set comprendente 6 anelli morbidi (art. 1739) e 36 nastri di 6 colori



1782
Give me Five
 Set aus 4 Stk. / Set da 4 pz.
 1 x ■ 1 x ■ 1 x ■ 1 x ■

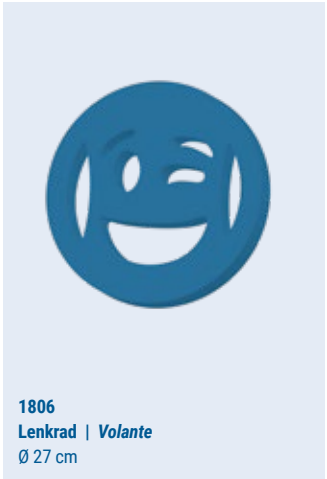

1806
Lenkrad | Volante
 Ø 27 cm



Snow Sail

S: 115 x 90 cm, < 6 Jahre / anni
 ■ 16929 ■ 30047 ■ 30048 ■ 30049 ■ 30050
 L: 130 x 105 cm, > 6 Jahre / anni
 ■ 16934 ■ 30052 ■ 30053



! Mindestbestellmenge: 5 Stück
 Ordine minimo: 5 pezzi

Snow Sail individuell | Snow Sail personalizzato

26059 S: 115 x 90 cm, < 6 Jahre / anni
 26061 L: 130 x 105 cm, > 6 Jahre / anni



Snow Snake

750 x 10 cm
 ■ 8236 ■ 37804 ■ 5884

Mit Blähton gefüllt, dadurch sehr leicht zu transportieren, aber schwer genug gegen Wind. Abriebfeste PU-Außenbeschichtung
 Riempito di argilla espansa e quindi leggero da trasportare ma abbastanza pesante per resistere al vento.
 Rivestimento esterno in PU resistente alle abrasioni



! Breite Skistellung garantiert!
 Posizione degli sci ampia e garantita!



Flitzbalken

Speed Bar
 250 x 30 x 30 cm
 ■ 35267 ■ 35268

Für die ersten Skiversuche und als Abgrenzung einsetzbar, individuelles Design möglich
 Possibilità d'impiego per le prime uscite sugli sci e come delimitazione, eventuale personalizzazione del design



Aufstiegsteppich Plus
 Tappeto per la risalita Plus

800 x 66 cm
 ■ 26058 ■ 34519

SCHNEEPFLUGHILFEN

AIUTO SPAZZANEVE



1781

Edgi Wedgi

Elastisches, weitenregulierbares Gummiband
 Material: Aluminium
 Nastro in gomma elastico regolabile in larghezza
 Materiale: Alluminio

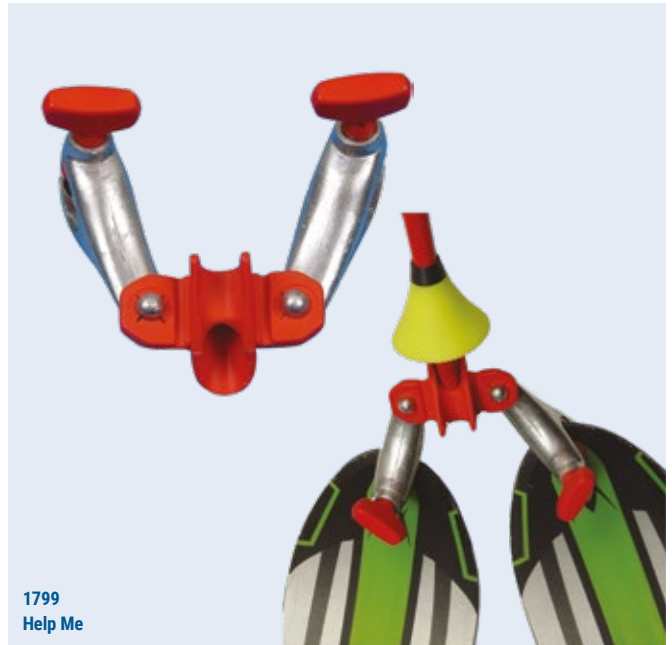

1799

Help Me

9695
Snow V

- Deutliche Entlastung im Kinderland und ein geregelter Ablauf
- Skianfänger kommen rascher auf ein homogenes Level
- Mehr Stabilität und Sicherheit – weniger Wackelkandidaten
- *Decongestionamento significativo dell'area bambini e uno svolgimento delle attività regolato*
- *Livello omogeneo raggiunto più rapidamente dai principianti*
- *Maggiori stabilità e sicurezza e meno traballamenti*

VIDEO 



**Lern mich kennen:
 3-wöchige Testmöglichkeit!**

*Venite a conoscermi:
 3 settimane di prova!*

VIDEO 



17648
V Assistant
 138 x 41 x 8 cm
 Die perfekte Ergänzung zum Snow-V
 L'accessorio perfetto per il sistema Snow-V



V Ride
16951 Pferd / Cavallo: 45 x 30 cm
16952 Motorrad / Motociclo: 45 x 24 cm



Kurvenfahren leicht gemacht!
Curvare facimente!



26062
V Fly
60 x 9 x 15 cm



Bremsen wie nie zuvor!
Frenate senza paragoni!



35311
V Pizza „Upgraded“
52 x 31 x 43 cm
• Inkl. höhenverstellbare Lenkstange
• Inkl. Führungsski
• Manubrio regolabile in altezza incluso
• Sci guida incluso

UPGRADE



Schneeflug-Einparkhilfe
Aiuto al parcheggio degli spazzaneve



53867
V Garage
750 x 15 x 15 cm
Inkl. Antirutschmatte
Tappetino antiscivolo incluso

NEW

RELAX & PLAY

Spielerisch entspannen

Egal, wo sie platziert sind: Unsere bunten und vielfältigen Sitzmöglichkeiten und Spielgeräte begeistern Jung und Alt. Die Produkte der Kategorie "Relax & Play" ermöglichen es, einfach mal abzuschalten und Pause zu machen. Auch kann die freie Zeit genützt werden, um sich mit den anderen Kindern auszutoben und sich besser kennenzulernen. Das Angebot ist so vielfältig wie die Wünsche unserer Kunden. Eines haben alle Produkte gemeinsam – sie schaffen Raum für Entspannung und unvergessliche Momente.

Relax giocando

A prescindere dalla loro collocazione, le varie e colorate sedute e attrezzature ludiche di Sunkid fanno la gioia di grandi e piccini. I prodotti della categoria Relax & Play consentono di staccare la spina e prendersi una pausa in modo semplice. Il tempo libero può anche essere utilizzato per dare libero sfogo a tutte le proprie energie insieme agli altri bambini e conoscersi meglio. L'offerta disponibile è tanto varia quanto i desideri dei clienti di Sunkid. Ma tutti i prodotti hanno una cosa in comune: offrono uno spazio per il relax e i momenti indimenticabili.



SITZMÖGLICHKEITEN

POSTAZIONI A SEDERE



1827
Sitzpolster | *Cuscino imbottito*
135 x 175 cm



8240
Chair XS
97 x 69 x 63 cm



8241
Chair
102 x 80 x 64 cm



8242
Lounger
180 x 85 x 69 cm



! Spielen und Relaxen zugleich!
Gioco e relax tutto in uno!

38041
Tetris Würfel | *Dado Tetris*
90 x 90 x 90 cm, 7 unterschiedliche Formen, Farben: rot, blau, grün, gelb
90 x 90 x 90 cm, 7 forme diverse, colori: rosso, blu verde, giallo



Würfel | Cubo
40 x 40 x 40 cm
■ 1686 ■ 1687 ■ 1688 ■ 1689



Bank | Panca
80 x 40 x 40 cm
■ 1694 ■ 1695 ■ 1696 ■ 1697

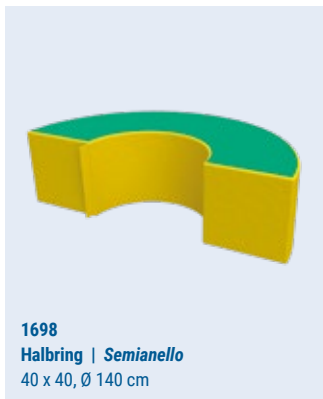

1698
Halbring | *Semianello*
40 x 40, Ø 140 cm



1841
Sitzbank | *Panca*
120 x 50 x 50 cm



30955
Sofa | *Divano*
100 x 50 x 50 cm

NEW



21012
Kids Alu Bank
Panca in alluminio per bambini
202 x 52 x 52 cm, 12,5 kg
• Inkl. Tragegriffe
• Inkl. gezahnten Bodenschienen
• Incl. Maniglie da trasporto
• Incl. Binari a terra dentati



8219
Elefant | *Elefante*
170 x 50 x 80 cm

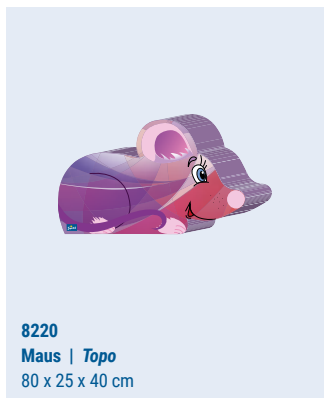

8220
Maus | *Topo*
80 x 25 x 40 cm



30954
Kuh | *Mucca*
130 x 80 x 40 cm



1705
Auto | *Macchina*
100 x 55 x 35 cm

SPIEL & SPASS

GIOCHI E DIVERTIMENTO

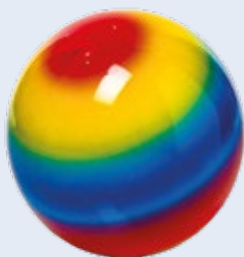

16923
Spielball Regenbogen
Palla arcobaleno
 Ø 18 cm
 Kunststoffmaterial mit Ventil
In plastica, con valvola

! Reißfest
 Antistrappo



1794
Würfel | Dado
 22 x 22 x 22 cm
 Material: PU-Schaum, wasserresistent
 Materiale: poliuretano espanso,
 prodotto resistente all'acqua



1793
Spieltuch | Tela da gioco
 Ø 3,5 m
 12 Halteschlaufen
 12 lacci



21006
Warm-up Würfel
Dado da riscaldamento
 17 x 17 x 17 cm
 4 teiliges Würfelset, inkl. Haltegriffe
 Set di dadi di 4 pz.
 con maniglie in dotazione



21017
Monster Puzzle, neunteilig
Monster puzzle da nove pezzi
 90 x 90 x 30 cm
 (ganzes Puzzle, tutto il puzzle)
 30 x 30 x 30 cm
 (ein Würfel, un dado)



5885
Schneeballwand (mit Löchern)
Parete delle palle di neve (con fori)
 190 x 200 x 15 cm



Aufblasbares Spielfeld | Campo gonfiabile
 Inkl. zwei Tore, Maße sind wählbar
 Incl. due porte, dimensioni a scelta



Aufblasbarer Igluformer | Iglù gonfiabile
1762 Medium Ø 3,5 m
1763 Large Ø 5 m
1764 X Large Ø 6,75 m
1765 XX Large Ø 8 m

UPGRADES UND INNOVATIONEN

AGGIORNAMENTI E INNOVAZIONI

Digitale Tipps und Tricks für Anwender

Das Portfolio von Sunny Stuff erleichtert den Skischulalltag, ist intuitiv einsetzbar und macht einfach Spaß. Damit auch die Vorbereitung von Unterricht sowie Lernareal schnell und reibungslos erfolgt, finden Sie auf immer mehr Sunny-Stuff-Produkten QR-Codes mit Direktlinks zu:

- Auf- und Abbauinfos
- Betriebsanleitungen
- Videos zum korrekten Einsatz des Lehrmaterials

Consigli e suggerimenti digitali per gli utenti

Il portfolio Sunny Stuff semplifica la vita quotidiana della scuola di sci, è intuitivo da usare e semplicemente divertente. Per rendere la preparazione delle lezioni e delle aree di apprendimento rapida e agevole, su un numero sempre maggiore di prodotti Sunny Stuff sono presenti codici QR con link diretti a:

- Informazioni sul montaggio e lo smontaggio
- Istruzioni per l'uso
- Video su come utilizzare correttamente il materiale didattico



Sicherer Stand und einfaches Handling

Sparen Sie sich zukünftig lästiges Löcherbohren beim Aufstellen, Umplatieren oder Verschieben Ihrer Schaumstofffiguren. Elemente bis 100 cm Höhe erhalten Sie ab sofort wahlweise auch mit speziellen Antirutschmatten, die sicheren Halt auf Eis und Schnee garantieren. Praktische Handschlaufen erleichtern Ihnen das Tragen.

Supporto sicuro e maneggevolezza

Risparmiatevi la fatica di praticare fori quando montate, riposizionate o spostate le figure in schiuma. Gli elementi alti fino a 100 cm sono ora disponibili anche con speciali tappetini antiscivolo che garantiscono una presa sicura su ghiaccio e neve. I pratici passanti per le mani ne facilitano il trasporto.





PORTALS & SIGNS

PORTALI E INSEGNE

Wir setzen ein Zeichen

Infopoint, Eye-Catcher, Markierung, Werbeträger oder Element zur Pistengestaltung: All das können unsere Eingangsbögen und Toucans sein. Ausgestattet mit Lautsprechern oder Displays, vermitteln die Toucans Ihren Gästen Informationen, erzählen Geschichten oder sind Teil von Rennstrecken, Sunline oder thematisierten Pisten. Der Toucan kann mit einem Gong oder Ball upgegradet werden.

Abbiamo messo un segno

Gli archi d'accesso, i tucani e le banane di Sunkid possono trasformarsi in punti informazioni, Eye-Catcher, indicazioni, pannelli pubblicitari o elementi per l'allestimento delle piste. Una volta dotati di diffusori e display, i tucani offrono informazioni, raccontano storie o sono parte integrante dei tracciati da competizione, Sunline o piste a tema. Puoi aggiornare il tucano con un gong o una palla.

TOUCAN & CO

Außen Freiraum für Kreativität, innen bewährte Sunkid-Technik für Stabilität und Haltbarkeit

Egal ob extreme Windverhältnisse oder enorme Schneefälle binnen kurzer Zeit: Unsere Toucans & Co sind gerüstet und standhaft. Überzeugen Sie sich von der innovativen Technik unter dem attraktiven Überzug.

Fuori spazio alla creatività, dentro la collaudata tecnologia sunkid per maggiore stabilità e durata.

Con condizioni di vento estreme o di enormi nevicate in un breve arco di tempo, i tucani e gli accessori di Sunkid rimangono ben strutturati e stabili grazie ad una tecnologia innovativa celata sotto ad un attraente rivestimento.

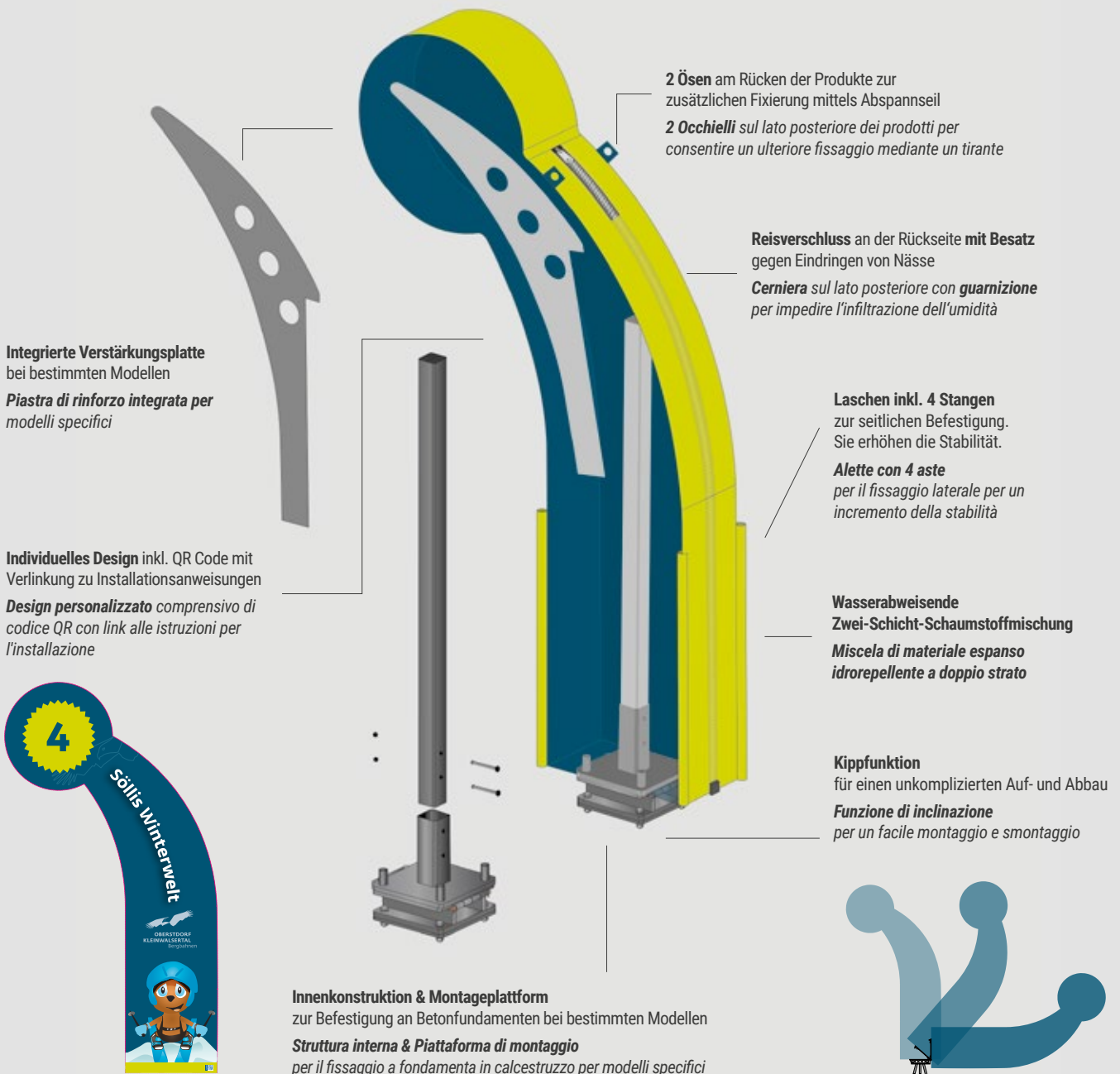

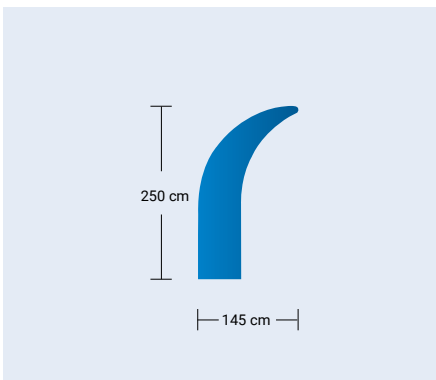

1835
Toucan M

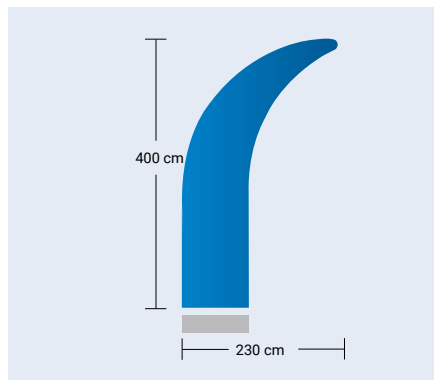

1834
Toucan L

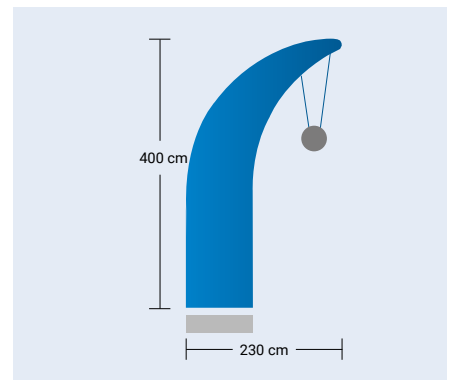

Toucan L
39176 mit Ball / con palla
39177 mit Gong / con gong

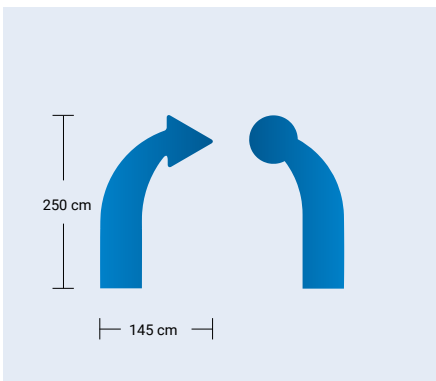

26063
Toucan M
Pfeil/Kreis | freccia/cerchio

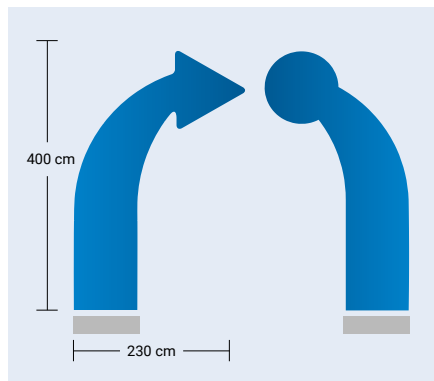

35520
Toucan L
Pfeil/Kreis | freccia/cerchio

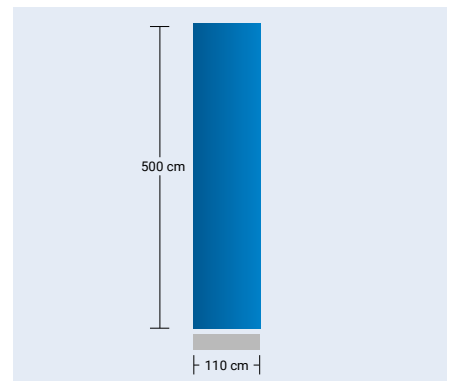

30754
Säule | Colonna

EINGANGSBOGEN

ARCO D'INGRESSO



2907
Eingangsbogen XS
Arco d'ingresso XS



1728
Eingangsbogen S
Arco d'ingresso S



1727
Eingangsbogen M
Arco d'ingresso M



1725
Sonnenbogen
Arco con Sole



1833
Eingangsbogen XL
Arco d'ingresso XL

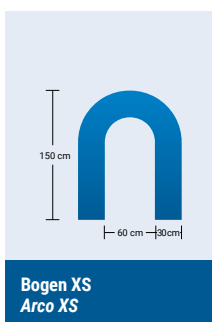

Bogen XS
Arco XS

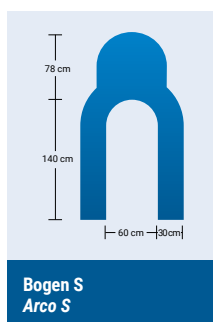

Bogen S
Arco S

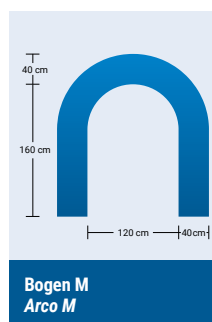

Bogen M
Arco M

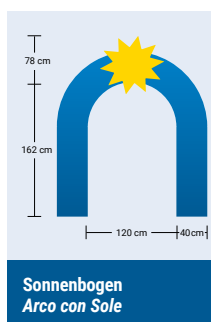

Sonnenbogen
Arco con Sole

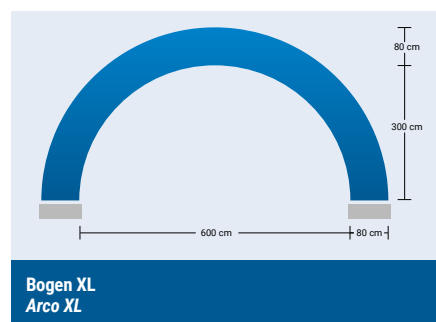

Bogen XL
Arco XL

Innovative Upgrades: Seite 25

Aggiornamenti innovativi: Pagina 25

EQUIPMENT

Das Highlight auf jeder Skipiste

Eine Umgebung, in der Kinder sich wohlfühlen, die Jugendliche und Erwachsene auf unterhaltsame und abwechslungsreiche Weise animiert: Darin liegt unser Hauptaugenmerk und unsere Leidenschaft. Neben kindgerecht gestalteten Figuren spielt auch die Pistengestaltung eine bedeutende Rolle – Langeweile im Kinderland oder auf der Skipiste gehört jetzt der Vergangenheit an.

Il pezzo forte su ogni pista da sci

Sunkid concentra la propria attenzione principale e la propria passione su un ambiente in cui i bambini si sentono a proprio agio stimolando i giovani e gli adulti grazie all'intrattenimento e alla varietà. Oltre alle immagini orientate ai bambini, anche l'allestimento delle piste riveste un ruolo significativo: la noia nel mondo dei bambini o sulle piste da sci è un ricordo del passato.



MONSTER FAMILY



21022
High/Low 5 Mini
60 x 40 x 10 cm



21021
High/Low 5 Medium
100 x 40 x 10 cm



21023
Triple Clap
80 x Ø 20 cm



30928
Twister
100 x 40 x 10 cm



12716
Ski-Boxing
150 x 60 x 20 cm
Boxsack höhenverstellbar, inkl. Bodenverankerung
Sacco da boxe regolabile in altezza, ancoraggio a terra incluso



12725
High/Low 5 Maxi
150 x 60 x 20 cm
Hände seitlich durchgehend höhenverstellbar
Mani laterali regolabili in altezza senza scatti

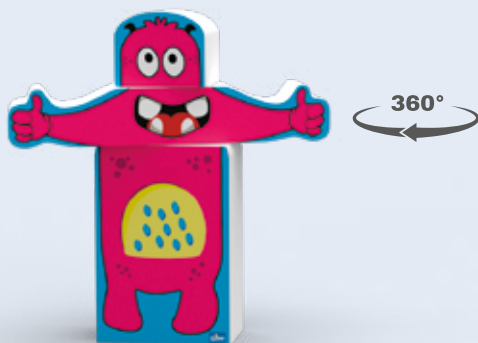

12713
Turn-around
150 x 60 (140) x 20 cm
Arme 360° drehbar
Bracci girevoli a 360 gradi



12727
Ski-Limbo
150 x 60 x 20 cm
Limbo-Querstange höhenverstellbar
Barra per il limbo regolabile in altezza



35257
Monster Rolle gelb
Rullo monster giallo
 80 x 30 cm



30333
Monster Rolle violett
Rullo monster viola
 80 x 30 cm



30334
Monster Rolle grün
Rullo monster verde
 80 x 30 cm



35259
Monster Rolle rot
Rullo monster rosso
 80 x 30 cm



30331
Monster Spin gelb
Monster spin giallo
 100 x 104 x 12 cm



30332
Monster Spin violett
Monster spin viola
 100 x 104 x 12 cm



30326
Monster Spin grün
Monster spin verde
 100 x 104 x 12 cm



30328
Monster Spin rot
Monster spin rosso
 100 x 104 x 12 cm



30693
Monster Bogen gelb
Monster arco giallo
 138 x 166 x 25 cm



35263
Monster Bogen violett
Monster arco viola
 138 x 166 x 25 cm



35264
Monster Bogen grün
Monster arco verde
 138 x 166 x 25 cm



30692
Monster Bogen rot
Monster arco rosso
 138 x 166 x 25 cm

INTERAKTIVER SKIKINDERGARTEN

ASILO DA SCI INTERATTIVO



8866
Element 1 | Elemento 1
90 x 94 cm
Beidseitig bedruckte Plane
Telone stampato su entrambi i lati



8867
Element 2 | Elemento 2
90 x 94 cm
Beidseitig bedruckte Fransenplane
Telone stampato su entrambi i lati con incisioni



8868
Element 3 | Elemento 3
90 x 94 cm
Beidseitig bedruckte Plane mit Schaumstofffüllung
Telone stampato su entrambi i lati con schiuma



8869
Element 4 | Elemento 4
105 x 32 cm
Beidseitig bedruckte Plane mit Schaumstofffüllung
Telone stampato su entrambi i lati con schiuma



8870
Element 5 | Elemento 5
130 x 20 x 20 cm
Bedrucktes Schaumstoffkarussell
Giostra in schiuma con stampe



8871
Element 6 | Elemento 6
60 x 60 cm
Beidseitig bedruckte Plane mit Schaumstofffüllung
Telone stampato su entrambi i lati con schiuma



25805
Element 7 | Elemento 7
33 x 20 cm
Beidseitig bedruckte Plane mit Schaumstofffüllung
Telone stampato su entrambi i lati con schiuma



6136
Interaktiver Skikindergarten Set | Asilo sulla neve interattivo Set
Set bestehend aus 7 Elementen
Set formato da 7 elementi

SET

SNOW ANIMALS



30959
Grizy
100 x 60 x 15 cm



38043
Kenai
100 x 60 x 15 cm

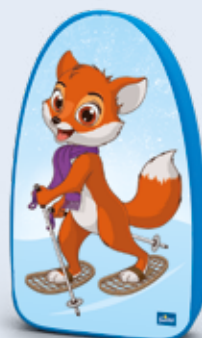

34387
Fiona
100 x 60 x 15 cm



30963
Ranger
100 x 60 x 15 cm



34389
Daisy
100 x 60 x 15 cm



30961
Buddy
100 x 60 x 15 cm



30965
Stella
100 x 60 x 15 cm



38052
Amigo
100 x 60 x 15 cm



30967
Heidi
100 x 60 x 15 cm



34376
Henry
100 x 60 x 15 cm



34391
Bambi
100 x 60 x 15 cm



34383
Rudi
100 x 60 x 15 cm



38045
Grace
100 x 60 x 15 cm



30957
Rocky
100 x 60 x 15 cm



30975
Sweetie
100 x 66 x 15 cm



38048
Felix
100 x 66 x 15 cm



38053
Kibali
100 x 66 x 15 cm



34385
Benny
100 x 66 x 15 cm



38051
Kiara
100 x 66 x 15 cm



30973
Leo
100 x 66 x 15 cm



30971
Elsa
100 x 84 x 15 cm



34381
Sam
100 x 84 x 15 cm



34379
Shira
100 x 84 x 15 cm



30969
Sonic
100 x 84 x 15 cm

TROLL FAMILY



38798
Mama Troll | *Mama Troll*
60 x 30 x 15 cm



38799
Papa Troll | *Papà Troll*
60 x 30 x 15 cm



38800
Junior Troll | *Figlio Troll*
60 x 30 x 15 cm



38796
Oma Troll | *Nonna Troll*
60 x 30 x 15 cm



38797
Opa Troll | *Nonno Troll*
60 x 30 x 15 cm

Alle Trolle inkl. Kippstange!
Tutti i troll incl. asta d'inclinazione!



SKIREGELN

REGOLE PER SCIARE



Skiregeln Flyer
Regole per sciare volante



Skiregeln Schilder
Segnali delle regole dello sci
Material: Aluminium oder Schaumstoff
Materiale: alluminio o materiale espanso



35209
Skiregeln Würfel
Regole per sciare cubo

VERKEHRSZEICHEN, WALDABFAHRT & LAUTSPRECHER

SEGNALETICA, DISCESA NEL BOSCO E ALTOPARLANTI



2927
Pfeil links | *Freccia a sinistra*
Ø 50 x 10 cm



2928
Pfeil rechts | *Freccia a destra*
Ø 50 x 10 cm



2929
Pfeil geradeaus | *Freccia diritta*
50 x 50 x 10 cm



2930
Stop | *Stop*
50 x 50 x 10 cm



2931
Bodenwelle | *Dozzo*
50 x 50 x 10 cm



2932
Engpass | *Restringimento*
50 x 50 x 10 cm



2933
Ampel | *Semaforo*
50 x 15 x 10 cm



48056
Polizist | *Poliziotto*
125 x 65 x 15 cm



2962
Baumstumpf mit Gesicht
Ceppo d'albero con faccia
80 x 30 cm



2963
Baumstumpf | *Ceppo*
80 x 30 cm



8258
Baum | *Albero*
90 x 70 x 20 cm

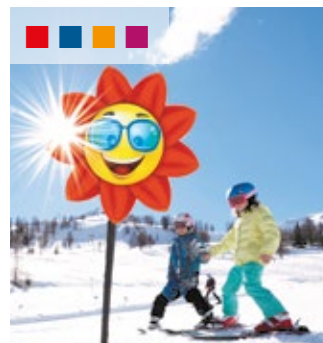

26064
Schneublume | *Fiore nella neve*
h = 160 cm, Ø 75 cm



1748
Rehbock | *Capriolo*
66 x 115 cm



1749
Mufflon | *Muflone*
86 x 90 cm



1750
Gämse | *Camoscio*
86 x 90 cm



1751
Dammhirsch | *Daino*
90 x 140 cm



1752
Birkhahn | *Fagiano*
58 x 54 cm



1753
Murmeltier | *Marmotta*
59 x 29 cm



1754
Fuchs | *Volpe*
60 x 55 cm



1755
Hase | *Lepre*
77 x 30 cm



1756
Steinbock | *Stambecco*
90 x 155 cm



1757
Königseule | *Civetta*
73 x 35 cm



30104
Braunbär | *Orso bruno*
112 x 103 cm



30106
Rothirsch | *Cervo*
175 x 147 cm



30107
Wildschwein-Zwillinge
Gemelli di cinghiale
57 x 35 cm



12672
Wolf | *Lupo*
123 x 70 cm



1758
Lautsprecher Variante 1 | *Altoparlanti Variante 1*
Lautsprecher mit Bewegungsmelder
Altoparlanti con rilevatore di movimento



21026
Lautsprecher Variante 2 | *Altoparlanti Variante 2*
Lautsprecher mit Button
Altoparlanti con pulsante



21027
Lautsprecher Variante 3 | *Altoparlanti Variante 3*
Lautsprecher mit externem Button und Kabel
Altoparlanti con pulsante esterno e cavo

RACE-ELLIPSEN

ELLISSI DA GARA

Alle Ellipsen inkl. Kippstange!

Tutti i ellissi incl. asta d'inclinazione!



38022
Race Ellipse 1
Ellisse da gara 1
60 x 20 x 10 cm



38023
Race Ellipse 2
Ellisse da gara 2
60 x 20 x 10 cm

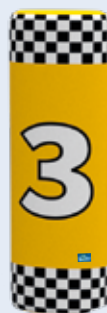

38024
Race Ellipse 3
Ellisse da gara 3
60 x 20 x 10 cm

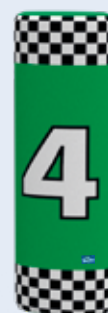

38025
Race Ellipse 4
Ellisse da gara 4
60 x 20 x 10 cm



38026
Race Ellipse 5
Ellisse da gara 5
60 x 20 x 10 cm



38027
Race Ellipse 6
Ellisse da gara 6
60 x 20 x 10 cm



38028
Race Ellipse 7
Ellisse da gara 7
60 x 20 x 10 cm



38029
Race Ellipse 8
Ellisse da gara 8
60 x 20 x 10 cm



38030
Race Ellipse 9
Ellisse da gara 9
60 x 20 x 10 cm



8272
Startsäule
Colonna Partenza
120 x 30 x 10 cm



8270
Zielsäule
Colonna Arrivo
120 x 30 x 10 cm



SET

12684
Race Ellipse Set
Set di ellissi da gara
Bestehend aus 9 Ellipsen
Set formato da 9 ellissi

KIDS OBSTACLES

Geringes Gewicht
Peso contenuto

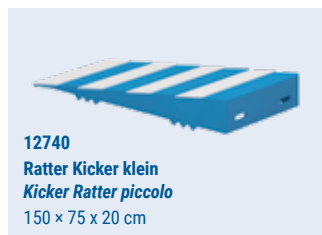
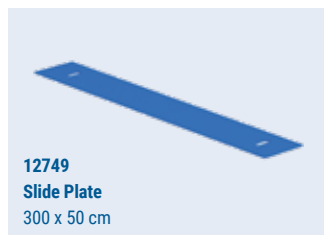
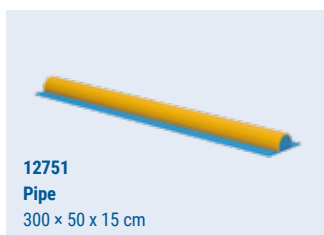
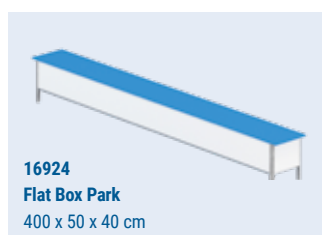
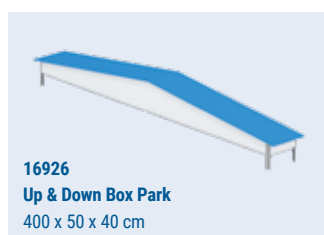



RACE

Auf die Plätze, fertig, los!

Das Abschlussrennen am Ende eines Skikurses bietet immer ein besonderes Erlebnis für alle Teilnehmer und deren Familien. Dort wird gezeigt, was man während des Kurses gelernt hat. Um die Rennabfahrt abwechslungsreich und noch spannender zu gestalten, bieten wir eine Vielzahl an Race-Produkten, welche auch abseits des Skiunterrichts eingesetzt werden können. Diese Produkte begeistern sogar erfahrene Wintersportler und motivieren, eigene Bestzeiten zu schlagen.

Pronti, partenza e via!

La gara finale al termine di un corso di sci è sempre un'esperienza speciale per i partecipanti e le rispettive famiglie perché dimostra le abilità apprese durante le lezioni. Per rendere la discesa varia e ancora più emozionante, è disponibile un'ampia gamma di prodotti da gara che è possibile utilizzare anche al di fuori delle lezioni di sci. Questi prodotti sono d'ispirazione anche per gli appassionati di sport invernali più esperti e li incitano a battere i loro record personali.



Startnummern
Numeri di partenza
Unterschiedliche Größen erhältlich
Diverse taglie disponibili



Kennzeichnungswesten | Gilet identificativo
Größen: 38 x 46 cm, 45 x 55 cm, 58 x 72 cm
Optionen: Reflexstreifen, Klarsichttaschen, Gummizug oder Klettverschluss
Taglie: 38 x 46 cm, 45 x 55 cm, 58 x 72 cm
Opzioni: strisce catarifrangenti, tasche trasparenti, elastico o chiusura con velcro



Kidsmarker
Indicatori per bambini
37 x 46 cm
Inkl. Klettverschluss und reflektierenden Streifen, individueller Aufdruck auf der weißen Fläche möglich
Incl. chiusura in velcro e strisce catarifrangenti, eventuale stampa personalizzata su fondo bianco



8257
Kindertor individuell
Porta per bambini personalizzabile
Flaggengröße 50 x 35 cm, inkl. Rutschsicherung, inkl. vollflächigen Digitaldruck
incl. dimensione della bandiera 50 x 35 cm, dispositivo antiscivolo, incl. stampa digitale su tutta la superficie



Inkl. Torstangen
Incl. paletti

Kindertore
Porte per bambini
■ 1804 ■ 1805



12792
Siegerpodest aus Aluminium
Podio in alluminio
175 x 50 x 60 cm
Gewicht / Peso 26 kg



STARTHAUS & ZIELSÄULEN

PUNTO DI PARTENZA & COLONNINE D'ARRIVO

STARTHAUS EVOLUS

- Breite: 400 cm, Länge: 445 cm, Höhe: 285 cm
- Aluminiumbogen mit Anbaukonsolen und 5 mm Polycarbonatscheiben
- Abdeckungen innen und außen aus verzinktem Blech
- Kundenindividuelles Design
- Montage auf kundenseitigem Unterbau oder Betonfundament

ZIELSÄULEN

- Zielsäulen in kundenindividuellen Formen und Größen erhältlich
- Optionale Integration von Zeitmess-, Audio-, und Videosystemen

PUNTO DI PARTENZA EVOLUS

- Larghezza: 400 cm, lunghezza: 445 cm, altezza: 285 cm
- Arco in alluminio con pannelli accessori e finestre in policarbonato da 5 mm
- Rivestimenti interni ed esterni in lamiera zincata
- Progettazione personalizzata
- Montaggio su piattaforma o fondamenta in calcestruzzo in loco

COLONNINE D'ARRIVO

- Disponibilità di colonnine d'arrivo con forme e dimensioni personalizzate
- Sistemi di cronometraggio, audio e video

Starthaus und Zielsäulen eignen sich auch für Speedstrecken sowie Sunlines aller Art und können nach Wunsch thematisiert werden!

Il punto di partenza e le colonnine d'arrivo sono adatti anche ai tracciati veloci e a tutti i tipi di Sunline. Inoltre, si possono realizzare anche soluzioni a tema su richiesta!

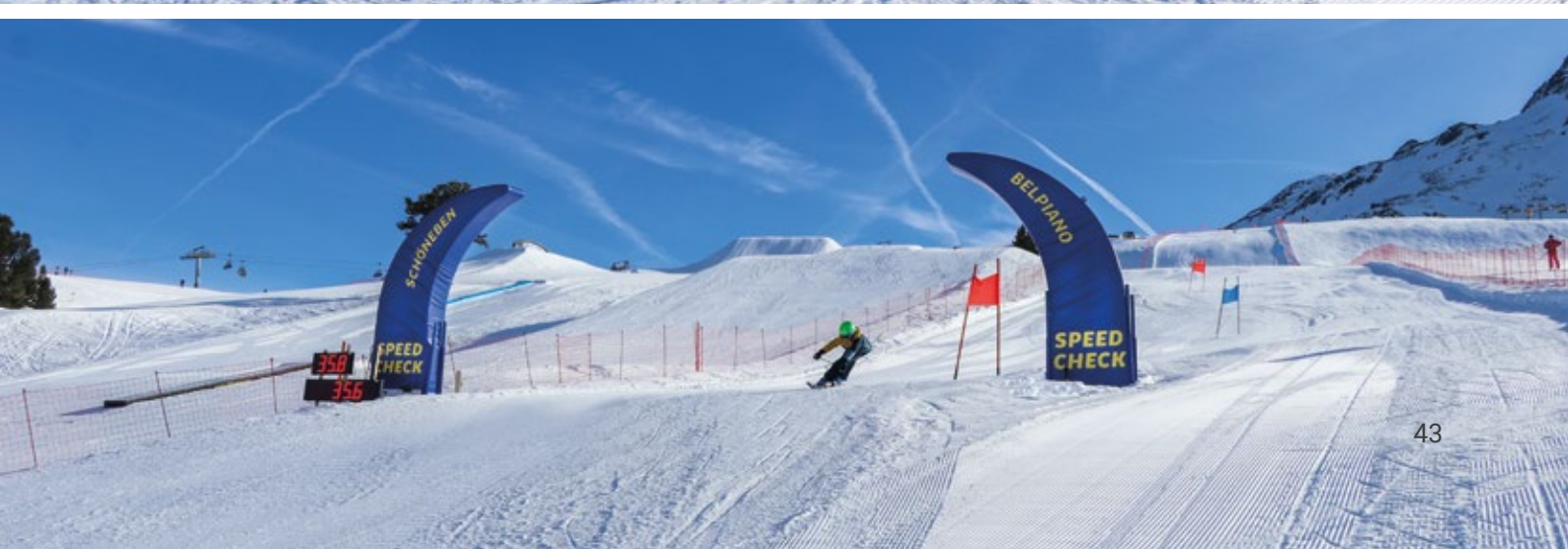

SUNLINE

Action & Fun

Bei einer Sunline dreht sich alles um das interaktive Erleben. Sie verbindet Spaß, Action und Abenteuer zu einem einzigartigen Erlebnis. Das Streckendesign mit Tunneln, Kurven, Sprüngen und vielem mehr bietet eine völlig neue Dimension des Wintersports. Die entlang der Strecke verteilten interaktiven Elemente wie Sound High Five, Sunline Rainbow Bridge & Co. verwandeln Ihre Sunline in ein Highlight Ihres Skigebiets.

Mit über 60 % der durchschnittlichen Gästestruktur eines Skigebiets sprechen derartige Erlebnispisten weit mehr Zielgruppen an als die meisten anderen Angebote im Winterurlaub.

Descrizione di Sunline

Con Sunline tutto gira intorno all'interattività. Riunisce divertimento, dinamicità e avventura per offrire esperienze uniche. La progettazione del tracciato, caratterizzato da tunnel, curve, salti e molti altri accessori, offre una dimensione del tutto nuova degli sport invernali. Gli elementi interattivi disseminati lungo il tracciato, come ad esempio Sound High Five, Sunline Rainbow Bridge & Co., trasformano Sunline nell'attrattiva del comprensorio sciistico.

Con oltre il 60% della struttura media degli ospiti di un comprensorio sciistico, queste piste avventurose si rivolgono a un numero di gruppi target di gran lunga superiore rispetto alla maggior parte delle altre offerte di vacanze invernali.



MODULAR TUNNEL

Breite: 280 cm, Durchfahrts Höhe: 200 cm
280 cm di larghezza, 200 cm di altezza del passaggio

Einfacher Aufbau
ohne Hilfsmittel
Montaggio semplice
senza utensili

Statisch geprüft – zur Überfahrt mit
Pistengerät geeignet
Stabilità garantita: soluzione adatta all'attraversamento con le attrezzature da pista

Zusätzliche Licht- und Soundeffekte
Effetti di luci e audio aggiuntivi

Kein Wegtauen des Schnees durch
integrierte Kälteisolierung
Assenza di neve disciolta grazie
all'isolamento integrato dal freddo

Für Schalung und Innenbereich
individuelles Branding wählbar
Possibilità di selezione del marchio
personalizzato per armatura e area
interna

Länge des Tunnels durch einzelne
Grundelemente frei wählbar
Lunghezza del tunnel completamente a
piacere grazie ai singoli componenti base





Startgate

Individuelle Form und Größe möglich
Possibilità di personalizzare forme e dimensioni



Hoop Race

Ø 200 cm
 360° drehbar
Ruotabile a 360°

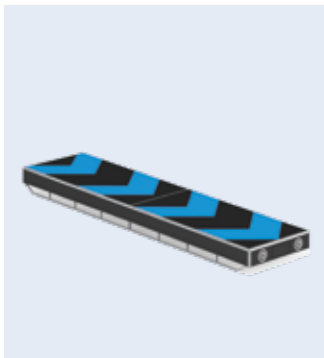

Speed Booster

600 x 127 x 25 cm
 Inkl. Soundmodul
Modulo audio incluso



Handybox

300 x 130 x 40 cm
 Inkl. Soundmodul
Modulo audio incluso

! Einfache Pflege mit Pistengerät
Facile manutenzione con il battipista



Rainbow Bridge

800 x 130 x 100 cm



Rolltreppe | Scala mobile

600 x 125 cm



Xylophon | Xilofono

300 x 240 x 20 cm

! Durchfahrt mit Pistengerät möglich
Possibilità di passaggio con battipista

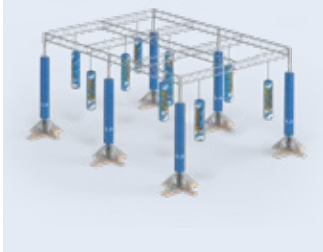

Pendelum

350 x 600 x 800 cm



Bulls Eye

200 x Ø 100 cm
 Sound optional möglich
Suono opzionale



Low Five

56 x 18 x 18 cm

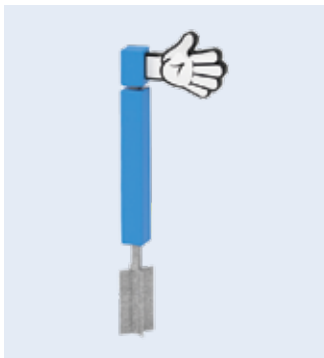

High Five

136 x 18 x 18 cm



Sound High Five

118 x 42 x 42 cm
 Inkl. Soundmodul
Modulo audio incluso



Drehfigur | Figura di svolta

118 x 42 x 18 cm



**Sound Drehfigur
 Figura sonora rotante**

220 x 42 x 42 cm
 Inkl. Soundmodul
Modulo audio incluso



Bonk

420 x 250 cm



Douple Bonk

420 x 240 cm



INTERAKTIVE RODELSTRECKE

PISTA DA SLITTINO INTERATTIVITA

Rodeln als interaktives Erlebnis

Skifahrer und Snowboarder lieben rasante Abfahrten in einer Sunline. Bieten Sie allen übrigen Wintergästen ein ähnlich spannungsgeladenes Erlebnis!

Zum Beispiel in Form einer perfekt präparierten, liebevoll thematisierten und vor allem interaktiven Rodelstrecke – bestückt mit individuellen Elementen unseres Sunline-Portfolios. Gerne unterstützen wir Sie bei Ihrer Planung.

Lo slittino come esperienza interattiva

Sciatori e snowboarder amano le discese veloci in Sunline. Offrite a tutti gli altri ospiti invernali un'esperienza altrettanto emozionante!

Ad esempio, sotto forma di una pista per slittini perfettamente preparata, curata nei minimi dettagli e soprattutto interattiva, equipaggiata con i singoli elementi della nostra gamma Sunline. Saremo lieti di assistervi nella pianificazione.



SNOW FUN PARK

So geht Spaß

Der Winter bietet so viele Möglichkeiten, Abenteuer auch abseits des Skifahrens zu erleben – warum darauf verzichten? Rutschen, fahren und gleiten Sie auf Pisten, Rodelbahnen, Tubing-Strecken oder drehen Sie sich einfach mal mit dem Rotondo im Kreis. Spielerisches Lernen und purer Freizeitpaß sind garantiert. Erweitern Sie das Angebot in Ihrem Skigebiet und sprechen Sie dadurch neue Zielgruppen an.

Il segreto del divertimento

L'inverno offre tantissime opportunità di divertimento e avventura anche lontano dallo sci. Perché perderselo? Corse e discese lungo piste, piste per slittini, tracciati da Tubing o giri semplicemente in tondo con Rotondo: queste soluzioni garantiscono la possibilità di imparare giocando e il tempo libero all'insegna del divertimento. È possibile ampliare l'offerta dell'impianto sciistico coinvolgendo altre fasce del pubblico di destinazione.



21010
Fun Balancer
66 x 16 x 36 cm



1830
Snow Future
117 x 50 x 30 cm



16942
Snow Glider
Ø 39 cm



16941
Fun Ufo
Ø 65 cm
Inkl. beidseitige Bremsgriffe
Leve del freno su entrambi i lati incl.



47166
Skilde Bob
66 cm
inkl. Haltegriff | *incl. maniglia*



1831
Snow Shuttle Deluxe
109 x 47 x 35 cm



1832
Snow Fox
95 x 50 x 23 cm
inkl. Lenkrad und Bremse
Volante e freno incl.

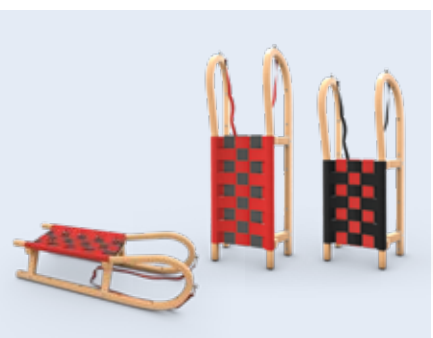

1814 / 1815 / 1816
Zweisitzer-, Einsitzer-, Jugend-Rodel
Slittino biposto, monoposto, da bambini
Auch als robuste Verleihvariante erhältlich
Slittini da noleggio, anche con telaio di metallo massiccio

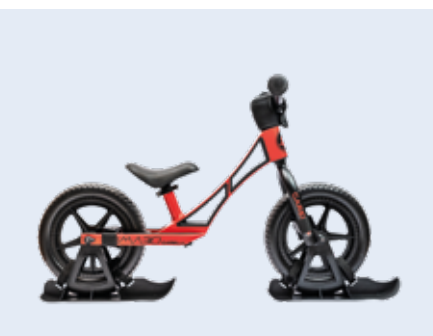

21011
Mini Skibike
Inkl. abnehmbaren Kufen
Incl. guide di scorrimento rimovibili



Auch Sommernutzung möglich!
Articolo utilizzabile anche in estate!



TUBES

Rasanter Spaß an 365 Tagen im Jahr

Im Winter auf präparierten Schneebahnen, im Sommer auf Kunststoffpisten: Eine Tubing-Anlage ist die ideale Angebotserweiterung für Skischulen und Bergbahnen. Sunkid bietet dabei alles aus einer Hand: Bereitstellung von Tubing-Reifen, Errichtung von Kunststoffpisten, Installation eines Zauberteppiches, ...

Divertimento frenetico 365 giorni all'anno

In inverno su piste di neve battuta, in estate su piste di plastica: un impianto di Tubing è l'estensione ideale dell'offerta per le scuole di sci e le ferrovie di montagna. Sunkid offre tutto da un unico fornitore: fornitura di pneumatici per tubing, costruzione di piste in plastica, installazione di un Moving Carpet, ...



Tube Standard Gommone da tubing Standard

6477 30 x 100 cm
3206 30 x 130 cm

- Textilverstärkter Überzug
- Farben: ■ ■ ■ ■ ■
- Individueller, einseitiger Aufdruck in schwarz oder weiß möglich
- Rivestimento rinforzato in tessuto
- Colori: ■ ■ ■ ■ ■
- Su richiesta: stampe personalizzate in bianco o nero su un lato



Tube EVO Gommone da tubing EVO

16728 30 x 80 cm
1720 30 x 100 cm
16727 30 x 130 cm

- Standarddesign-Überzug: Regenbogen
- Textilverstärkter Überzug digital bedruckbar
- Innen weiches Sitzpolster mit Aufdruck von Sicherheitsregeln
- Design standard del rivestimento: arcobaleno
- Rivestimento rinforzato in tessuto con possibili stampe digitali 4C
- Morbido cuscino interno riportante le norme di sicurezza

ROTONDO

Individuelles Design!
Progettazione personalizzata!

Das Bergkarussell für Winter und Sommer

Das Original Ski- und Tubing-Karussell, das im Winter wie im Sommer mit seiner Vielseitigkeit überzeugt und gleichermaßen für spielerisches Lernen als auch puren Freizeitspaß steht.

Gleichgewichtsübungen zur Vorbereitung für den Tellerlift oder einfach nur als Pausenunterhaltung während des Skikurses, für das alles ist unser Rotondo wie geschaffen. Im Sommer begeistert es Familien als Schaukelkarussell oder Tubingspaß auf Dry Slopes.

Giostra di montagna per l'inverno e l'estate

Questa originale giostra da sci e Tubing soddisfa le esigenze dei visitatori in inverno e in estate grazie alla sua versatilità e allo stesso modo è sinonimo di grande divertimento per il tempo libero per un apprendimento ludico.

Rotondo è stato appositamente creato per gli esercizi d'equilibrio mirati alla preparazione allo ski-lift a piatti o semplicemente come intrattenimento per le pause durante i corsi di sci. In generale si rivela una vera e propria sorpresa per le famiglie fungendo da giostra per altalene o intrattenimento per Tubing lungo i Dry Slope.



Handelsagentur
Harry Unterkircher
Eichenweg 4
6067 Absam
Tel.: +43(0)664/3107550
Email: harry@harrys-skischulbedarf.at
Internet: www.harrys-skischulbedarf.at